



Sawing on rails.

FESTOOL

Sawing with portable circular saws 03

Application overview | 47

Machine overview | 48

Circular saws | 50

TS 55, TS 75

Building materials saw | 54

AXT 50 LA

System overview and accessories | 55

Circular saw blades | 56

01

02

03

04

05

06

07

08

09

10

11

12

13

14

15

16

17

Almost no-one develops portable circular saws based as much on daily use as Festool does. This is why we invented the guide rail over 40 years ago and are constantly setting new standards with our circular saws. Together they are representative of a strength that makes Festool so unique: thinking as a system.

Sawing with portable circular saws

The quicker way for a cleaner cut.



Securely mounted and perfect guidance: circular saws combined with the MFT.

Modern portable circular saws have to meet many requirements. They have to be mobile and versatile but still have to work almost as precisely as bench-mounted tools. Festool makes this possible.

Circular saws fit perfectly onto the guide rail and the patented splinterguard ensures that cuts are as straight as they are splinter-free. The TS 55 and TS 75 circular saws are true examples of

versatility and mobility. They have many features such as the FastFix saw blade changing system and intelligent MMC electronics. And if you are impressed with the machine as a separate unit, you will be amazed when you see it as part of a system. Whether with a guide rail, combination bevel, multifunction table or effortless connection to a dust extractor, everything is compatible and optimises your work.

Benefits at a glance:

- Saw precisely along the scribe line using the rail
- Splinter-free cuts
- Long service life and sturdy design
- FastFix saw blade changing system
- Versatile operation with guide rail and multifunction table



Guide rail and attachable splinterguard for splinter-free cuts on both sides.



Safe, precise cuts with circular saws and guide rails from Festool: practical for any type of cut-out, even those with complicated geometric shapes.

FESTOOL The system



At Festool, we do not only think in terms of tools, but also in terms of systems so that you can work more quickly, easily and efficiently.



Saw blade system.

Best results with the right saw blade: Festool develops all its own blades for maximum performance

Circular saw blades from page 56

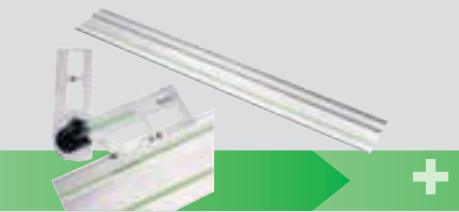

Guide system.

The guide system by Festool is the only way to produce precise, splinter-free cuts.

Guide systems from page 313

Application overview – Portable circular saws

You know best what the emphasis of your work is. The table below shows a selection of typical applications and indicates where the strengths of the individual tools lie. The details on the following pages will help you find the perfect solution.

	Circular saws		Building materials saw
	TS 55 55 mm	TS 75 75 mm	AXT 50 LA 47 mm
Maximum cutting depth			
Cutting out apertures for glass panes in internal doors	●	●	
Cutting out apertures for glass panes in house doors	◐	●	
Cutting doors to length	●	●	
Cutting panelling for radiators, ventilation systems and loudspeakers	●	◐	
Cutting recesses in kitchen worktops	●	◐	
Cutting false floors to size	○	●	
Cutting house doors to size, up to 75 mm thick	○	●	
Cutting conservatory framing to size, up to 75 mm thick	○	◐	
Cutting recesses in wooden workpieces and panels (coping)	◐	◐	
Cutting out old wooden flooring	●	●	
Cutting false joints	●		
Cutting expansion joints in parquet floors	●	◐	
Cutting chipboard to size	●	●	
Cutting veneered or plastic-laminated board	●	●	
Cutting plasterboard	●	◐	
Cutting aluminium sheets, panels and profiles	◐	◐	
Cutting plastic panels and profiles	◐	◐	
Cutting PVC and aluminium cable ducts to length	○	◐	
Trimming and cutting planks to length	○	●	
Rough cutting of boards at the timber yard	○	◐	
Cutting square timbers	○	◐	
Cutting steel cable ducts		●	
Cutting cement-bonded chipboard and fibreboard to size			●
Cutting synthetic-resin board			●

○ Appropriate ◐ Very appropriate ● Extremely appropriate



Extraction system.

Clean results both in the workshop and on the construction site with Festool mobile dust extractors.

Mobile dust extractors from page 281



Workspace system.

The multifunction table MFT – versatile in the workshop, practical for assembly.

Multifunction table from page 92



Storage system.

The SYSTAINER keeps your work area neat and tidy with storage space for machines and accessories.

Storage systems from page 337

Sawing with portable circular saws

Machine overview

Circular saw TS 55



Main applications

- Precise circular in materials up to 55 mm thick
- Cutting interior doors to length using guide rail and circular saw
- Manufacturing expansion joints in parquet flooring and false joints
- Cutting chipboard to size
- Cutting and processing plasterboard

Strengths and benefits

- FastFix: quick and easy saw blade changing and adaptation to the working material
- Spring-loaded spacer wedge for unhindered plunge cuts
- Attachable splinterguard for high-quality working results
- Quick-acting brake system for safe, convenient sawing
- Tool-less play setting on the guide rail

Next page 50

Technical data	
Power consumption	1200 W
Power consumption	1050 W
Idle engine speed	2000-5200 min ⁻¹
Idle engine speed	6500 min ⁻¹
Saw blade diameter	160 mm
Cutting depth at 45°/90°	0-43/0-55 mm
Connection Ø d/e	27/36 mm
Weight	4,5 kg
Weight	4,4 kg

■ = with MMC electronics



Circular saw TS 75



Main applications

- Precise circular in materials up to 75 mm thick
- Cutting house doors to length using guide rail and circular saw
- Cutting and machining conservatory profiles
- Cutting cable ducts to length cleanly and easily
- Accurately cutting false floors to size
- Cutting multilayered boards

Strengths and benefits

- FastFix: quick and easy saw blade changing and adaptation to the working material
- Spring-loaded spacer wedge for unhindered plunge cuts
- Attachable splinterguard for high-quality working results
- Quick-acting brake system for safe, convenient sawing
- Tool-less play setting on the guide rail

Next page 52

Technical data	
Power consumption	1600 W
Idle engine speed	1350-3550 min ⁻¹
Saw blade diameter	210 mm
Cutting depth at 45°/90°	0-55/0-75 mm
Connection Ø d/e	27/36 mm
Weight	6,2 kg

■ = with MMC electronics



Building materials saw AXT 50 LA



Main applications

- Cutting hard and extremely hard building panels
- Cutting cement-bonded board to size
- Cutting cement-bonded silicate panels
- Cutting cement-bonded chipboard to length
- Cutting fibre cement panels
- Cutting synthetic-resin bonded panels

Strengths and benefits

- Closed extraction hood with sealing brush for clean, dust-free work
- High torque at low speeds for hard materials
- Accurate, dust-protected roller guide on special guide rail

Next page 54

Technical data	
Power consumption	750 W
Saw blade speed	210 min ⁻¹
Saw blade diameter	170 mm
Cutting depth at 45°/90°	0-30/0-47 mm
Connection Ø d/e	27/36 mm
Weight	6,4 kg





Sawing with portable circular saws

Circular saw TS 55

Setting the standard for portable circular saws.

With the TS 55, Festool has defined the standards for plunge-cut saws. A host of refinements afford unique benefits for your work day-to-day.

FastFix saw blade changing system.

The saw blade can now be changed in just a few moves. This means you can change the blade more often to suit the material you are working on and save money.



Rotating extractor connector.

More freedom of movement; less dangerous obstacles. The suction hose never gets tangled or in the way and can always remain attached for maximum health protection.



Zero-play guidance.

No tools required to adjust the guidance jaws on the guide rail for accurate, zero-play guidance.



Splinterguard on both sides.

Splinter-free cuts on both sides. The attachable splinterguard and the guide rail make it possible.



Scribe line = cut.

Exact cuts, even at an angle. The TS 55 makes the actual cut right on the edge of the scribe line, even at an angle.



Spring-loaded spacer wedge.

It is always there when you need it and moves out of the way when you don't: the spring-loaded spacer wedge retracts into the housing during plunge cuts.



Scope of delivery

Order no.

operation tool

TS 55 EBQ-Plus-FS

fine tooth saw blade HW W48, guide rail FS 1400/2, splinterguard, in a SYSTAINER SYS 4 T-LOC

561508

TS 55 EBQ-FS

fine tooth saw blade HW W48, guide rail FS 1400/2, in a carton

561167

TS 55 Q-Plus-FS

HW Universal saw blade W28, guide rail FS 1400/2, splinterguard, in a SYSTAINER SYS 4 T-LOC

561509

TS 55 Q-FS

HW Universal saw blade W28, guide rail FS 1400/2, in a carton

561169

TS 55 EBQ-Plus

fine tooth saw blade HW W48, splinterguard, in a SYSTAINER SYS 4 T-LOC

561426

TS 55 EBQ

fine tooth saw blade HW W48, in a carton

561163

TS 55 Q-Plus

HW Universal saw blade W28, splinterguard, in a SYSTAINER SYS 4 T-LOC

561427

TS 55 Q

HW Universal saw blade W28, in a carton

561165

Accessories see page 55

The all-round talent up to 55 mm.



Quicker, better results.

Changing saw blades is quick and easy with the FastFix saw blade changing system. The correct saw blade is fitted in just a few moves – accurate, efficient sawing with the saw adapted to the material you are working on. This eliminates reworking and reduces sharpening costs.



System teamwork.

Comprehensive system accessories make your TS 55 more effective, more practical and quicker. Take the cover, for example, which improves the already excellent dust extraction and can also be used as a stop for sawing false joints.



Precision in series.

Large panel materials can be chopped quickly and simply with the parallel stop. The tool piece width is set using an adjustable stop and scales. Repeat cuts are made quickly and accurately – the ideal accessory for the guide rail.



Your mobile workshop.

How often do you have to unexpectedly clamp a workpiece? Workbenches are usually not available at the assembly site and this is where the multifunction table saves the day. Combined with the guide rail and the circular saw – your mobile workshop.



Planing no longer needed.

Festool invented the guide rail so that all your cuts turn out perfectly: Scribe a line, align the guide rail and away you go. No more time-consuming planing work when cutting doors to length, saving you time and money.

Technical data	
Power consumption	1200 W
Power consumption	1050 W
Idle engine speed	2000-5200 min ⁻¹
Idle engine speed	6500 min ⁻¹
Saw blade diameter	160 mm
Cutting depth at 45°/90°	0-43/0-55 mm
Connection Ø d/e	27/36 mm
Weight	4,5 kg
Weight	4,4 kg

■ = with MMC electronics

Sawing with portable circular saws

Circular saw TS 75

75 mm cuts and no competition.

No other circular saw offers a cutting depth of 75 millimetres and the many benefits that accompany it. A large selection of saw blades makes this saw even more impressive. Ideal for use in a wide range of applications.



<p>FastFix saw blade changing system. The saw blade can now be changed in just a few moves. This means you can change the blade more often to suit the material you are working on and save money.</p>	
<p>Kickback stop. Despite the power of the TS 75, a kickback stop is available to make absolutely sure that it does not kick back during plunge cuts. Always within reach in the practical store for safe working.</p>	
<p>Zero-play guidance. No tools required to adjust the guidance jaws on the guide rail for accurate, zero-play guidance.</p>	
<p>Splinterguard on both sides. Splinter-free cuts on both sides. The attachable splinterguard and the guide rail make it possible.</p>	
<p>Scribe line = cut. Exact cuts, even at an angle. The TS 75 makes the actual cut right on the edge of the scribe line, even at an angle.</p>	
<p>Spring-loaded spacer wedge. It is always there when you need it and moves out of the way when you don't: the spring-loaded spacer wedge retracts into the housing during plunge cuts.</p>	

Scope of delivery	Order no.
HW universal saw blade W 36, kickback stop, operation tool	
TS 75 EBQ-Plus-FS guide rail FS 1400/2, splinterguard, in a SYSTAINER SYS 5 T-LOC	561512
TS 75 EBQ-FS guide rail FS 1400/2, in a carton	561185
TS 75 EBQ-Plus splinterguard, in a SYSTAINER SYS 5 T-LOC	561436
TS 75 EBQ in a carton	561184

Accessories see page 55

Not only special because of its cutting depth.



No other saw cuts deeper.

Where conventional 65 mm machines reach their limits, the handy TS 75 really comes into its own. Together with the guide rail, the TS 75 allows for flexible working.



Always the right saw blade.

The same saw blade is often used to cut several different types of material because changing blades is simply too time-consuming. This obviously reduces the quality of the cut and the service life of the saw blade. But Festool has the solution: the FastFix saw blade changing system. It's as simple as that.

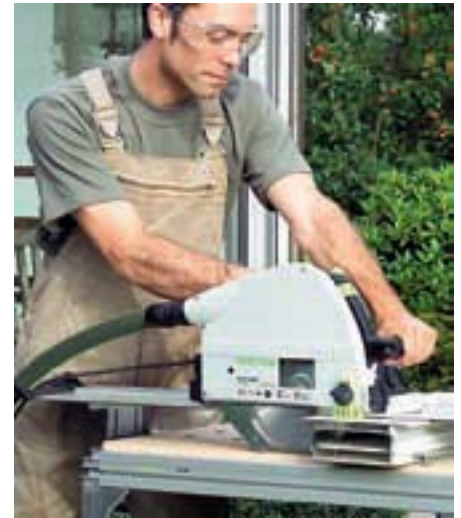

Accurate and easy.

The cutting depth of 75 mm and the famous circular principle are ideal for jobs involving larger workpieces and enable you to saw thick workpieces with one cut. This saves you having to turn the workpiece and minimises reworking.



Precision in series.

Large panel materials can be chopped quickly and simply with the parallel stop. The tool piece width is set using an adjustable stop and scales. Repeat cuts are made quickly and accurately – the ideal accessory for the guide rail.



A principle of flexibility.

For versatile and flexible applications. The correct saw blade and circular principle allow you to easily master trimming work on multilayered boards or cable ducts up to 75 mm thick.

Technical data	
Power consumption	1600 W
Idle engine speed	1350-3550 min ⁻¹
Saw blade diameter	210 mm
Cutting depth at 45°/90°	0-55/0-75 mm
Connection Ø d/e	27/36 mm
Weight	6,2 kg

 = with MMC electronics

01

02

03

04

05

06

07

08

09

10

11

12

13

14

15

16

17

Sawing with portable circular saws

Building materials saw AXT 50 LA

Professional for hard material.

Whatever type of building panel you need to cut, the AXT 50 LA can tackle it. From Duripanel and Eterplan to Iso-color, Suplux and Promatect, this building materials saw with special saw blade can cut a wide range of materials cleanly and safely.

Clean.

The AXT 50 LA can be used in combination with mobile dust extractors CTL, CTM or SR.

Enclosed housing.

The housing of the AXT 50 LA is completely enclosed to prevent dust from entering the inner mechanism, thereby extending the service life.

Brushes.

The extraction brushes run along the workpiece to maximise dust extraction.



Low speed – high torque.

The low cutting speed and high torque of the AXT 50 LA create the perfect conditions for cutting into extremely hard materials.

Reliable guidance.

The AXT 50 LA has a special guide plate with rollers to adapt the saw to the AXT guide rail. The benefit here is that dust on the rail does not slow the machine down.

The AXT 50 LA is particularly powerful and because of its low speed and high torque, can cut through the hardest materials, eg fibre cement panels. A special guide rail is available so that the AXT 50 LA can produce quality working results in spite of generating abrasive deposits. The guide rollers on the machine run smoothly along the guide rail and help produce a straight, clean cutting edge, even on the toughest materials.



A closed extraction hood and sealing brush for maximum dust extraction.



The specially developed guide rail for the AXT 50 LA helps produce perfect working results (available as an accessory).



The special saw blade for the AXT 50 LA cuts confidently through tough building panels and cement-bonded fibreboard.

Scope of delivery	Order no.
AXT 50 LA-Plus HW special carbide tipped saw blade, operation tool, in a SYSTAINER SYS 4 T-LOC	561442
Saw guide AUP 1750 special guide rail for AXT 50 LA, Length 1750 mm, in a carton	482543
Saw guide AUP 3000 special guide rail for AXT 50 LA, Length 3000 mm, in a carton	482544
Special saw blade 170x2,0x30 TF56 for AXT50LA, Diameter 170 mm, Cutting width 2,0 mm, Hole Ø 30 mm, No. of teeth 56, Chip angle -4 °, Tooth shape TF, in self-service display pack	435450

Technical data, see page 48

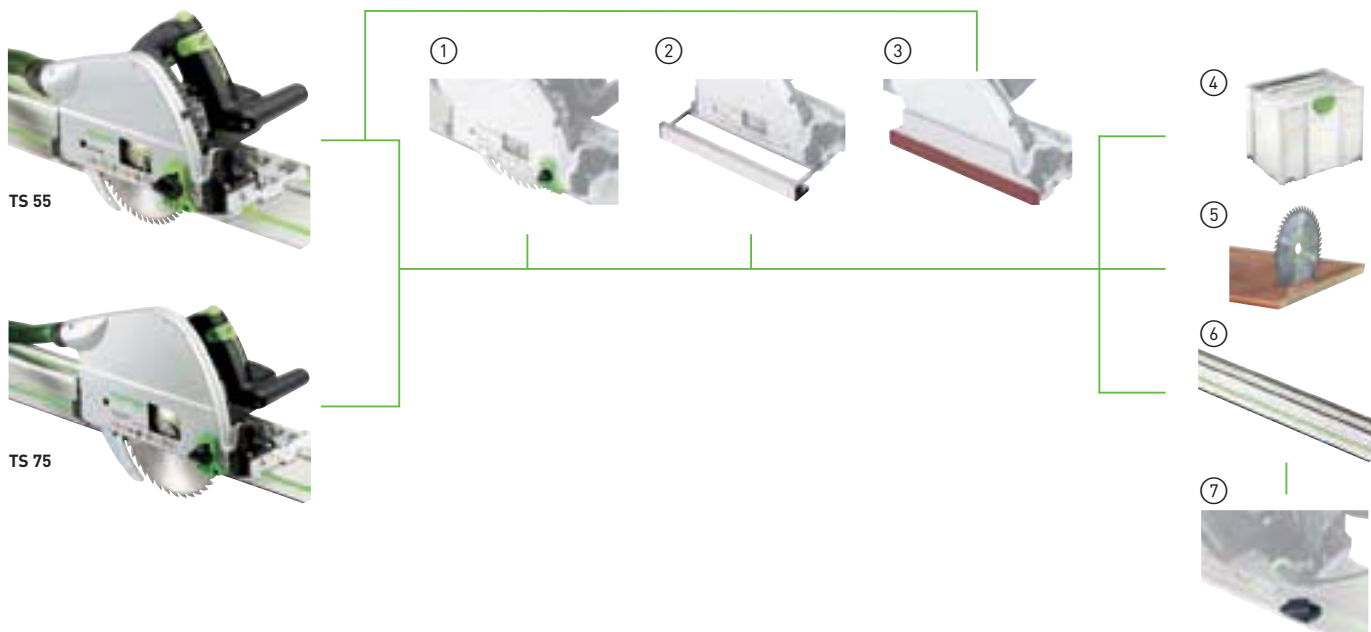













Accessories for circular saws TS 55 and TS 75

Product	Explanation	Order no.
① Splinter guard SP-TS 55/5	for TS 55 and TS 75, for low-splinter cuts to the right of the saw blade, can be used with or without guide rail, qty. in pack 5 pieces), in self-service display pack	491473
② Parallel side fence PA-TS 55	for TS 55, parallel guide, guided on both sides, can also be used as table extension, Max. workpiece width 100 mm, in a carton	491469
Parallel side fence PA-TS 75	for TS 75, parallel guide, guided on both sides, can also be used as table extension, Max. workpiece width 100 mm, in a carton	492243
③ Cover ABSA-TS 55	for TS 55, cover for improved dust extraction, can also be used as false joint set, width of the shadow gap 17-46 mm, in a carton	491750
④ SYSTAINER T-LOC SYS-TS 55	SYSTAINER size SYS 4 T-LOC	497681
SYSTAINER T-LOC SYS-TS 75	SYSTAINER size SYS 5 T-LOC	497682
⑤ Circular saw blades	from page 56	
⑥ Guide-rails	see "Guide system" section, from page 313	
⑦ Kickback stop FS-RSP	for TS 55, ATF 55, AP 55, AT 65, AP 65, AP 85, used as a rear and front stop position on guide rail FS/2, can also be used as guide stop, in self-service display pack	491582

Sawing with portable circular saws

Circular saw blades

The right saw blade for every application.

Colour code	Material	Speed range
		 3 – 6
		 3 – 5
		 1 – 6
		Fe 2 – 4
		Al 3 – 6



Cross-cut tooth saw blade (W and PW)

The teeth on this blade slope to the left and right and cut alternately. The alternate-tooth saw blade is a universal blade for all types of wood.

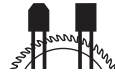

Flat trapezoidal tooth saw blade (TF)





























The edges of the trapezoidal teeth slant on both sides. They alternate with the flat teeth when cutting into the material.

This tooth shape is used for cutting aluminium, hard plastic and materials with hard coatings.



Flat tooth saw blade (F)

The edges of the teeth are straight, not sloping. Each tooth cuts in the same way. This saw blade is used for cutting steel.

	Grade	Order no.	Saw blade dia. ¹⁾	Centre bore dia. ¹⁾	Cutting width ¹⁾	Tooth angle ²⁾	Tooth shape	No. of teeth	Colour code
	Standard	486296	190	30	2,8	20	W	16	
	Standard	493197	210	30	2,6	20	W	18	
	Standard	437042	240	30	2,8	20	W	22	
	Panther	496301	160	20	2,2	20	PW	12	
	Panther	492049	190	FF ³⁾	2,6	28	PW	16	
	Panther	486298	190	30	2,8	37	PW	14	
	Panther	493196	210	30	2,6	28	PW	16	
	Panther	496303	225	30	2,6	28	PW	18	
	Panther	438698	240	30	2,8	38	PW	18	
	Universal	496302	160	20	2,2	15	W	28	
	Universal	492048	190	FF ³⁾	2,6	10	W	32	
	Universal	490517	190	30	2,8	15	W	32	
	Universal	493198	210	30	2,4	15	W	36	
	Universal	488288	225	30	2,6	20	W	32	
	Universal	490518	240	30	2,8	15	W	32	
	Universal	494604	260	30	2,5	-5	W	60	
	Fine tooth	491952	160	20	2,2	5	W	48	
	Fine tooth	492050	190	FF ³⁾	2,4	8	W	48	
	Fine tooth	486297	190	30	2,8	8	W	48	
	Fine tooth	493199	210	30	2,4	5	W	52	
	Fine tooth	491050	216	30	2,3	-5	W	48	
	Fine tooth	488289	225	30	2,6	10	W	48	
	Fine tooth	435187	240	30	2,8	10	W	48	
	Fine tooth	494605	260	30	2,5	-5	W	80	
	Fine tooth								

Recommended speed range

¹⁾ indicated in mm











²⁾ indicated in °

³⁾ FF = FastFix interface

Sawing with portable circular saws

Circular saw blades

The right saw blade for every application.

Colour code	Material	Speed range
		3 – 6
		3 – 5
		1 – 6
		Fe 2 – 4
		Al 3 – 6



Cross-cut tooth saw blade (W and PW)

The teeth on this blade slope to the left and right and cut alternately. The alternate-tooth saw blade is a universal blade for all types of wood.

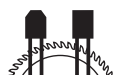

Flat trapezoidal tooth saw blade (TF)





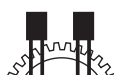





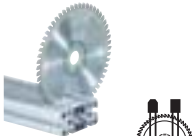





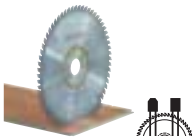

The edges of the trapezoidal teeth slant on both sides. They alternate with the flat teeth when cutting into the material.

This tooth shape is used for cutting aluminium, hard plastic and materials with hard coatings.



Flat tooth saw blade (F)

The edges of the teeth are straight, not sloping. Each tooth cuts in the same way. This saw blade is used for cutting steel.

	Grade	Order no.	Saw blade dia. ¹⁾	Centre bore dia. ¹⁾	Cutting width ¹⁾	Tooth angle ²⁾	Tooth shape	No. of teeth	Colour code
	Aluminium/plastic	496306	160	20	2,2	-5	TF	52	
	Aluminium/plastic	492051	190	FF ³⁾	2,6	-5	TF	58	
	Aluminium/plastic	486299	190	30	2,8	-5	TF	68	
	Aluminium/plastic	493201	210	30	2,4	-5	TF	72	
	Aluminium/plastic	491051	216	30	2,3	-5	W	60	
	Aluminium/plastic	488291	225	30	2,6	-5	TF	68	
	Aluminium/plastic	438638	240	30	2,8	-5	TF	80	
	Laminate/mineral material	496308	160	20	2,2	4	TF	48	
	Laminate/mineral material	492052	190	FF ³⁾	2,6	4	TF	54	
	Laminate/mineral material	489458	190	30	2,6	4	TF	54	
	Laminate/mineral material	493200	210	30	2,4	4	TF	60	
	Laminate/mineral material	489459	225	30	2,6	4	TF	64	
	Laminate/mineral material	494606	260	30	2,5	-5	TF	64	
	Steel/Multilayered board	493351	210	30	2,2	1	F	36	
	Steel/Multilayered board	487271	240	30	2,6	1	F	48	
	Building panels	435450	170	30	2,0	8(-4)	TF	56	

Recommended speed range

¹⁾ indicated in mm

²⁾ indicated in °

³⁾ FF = FastFix interface

